



## TENSILE PROPERTIES OF SINGLE FLAX FIBRES

Betts, Dillon<sup>1</sup>, Sadeghian, Pedram<sup>1,3</sup> and Fam, Amir<sup>2</sup>

<sup>1</sup> Department of Civil and Resource Engineering, Dalhousie University, Canada

<sup>2</sup> Department of Civil Engineering, Queen's University, Canada

<sup>3</sup> [pedram.sadeghian@dal.ca](mailto:pedram.sadeghian@dal.ca)

**Abstract:** The stress-strain response of flax fiber-reinforced polymer (FFRP) composites (and other plant-based FRPs) loaded in tension is nonlinear. It has been determined in previous studies that this nonlinear behaviour is not caused by the matrix or specimen shape. Therefore, there is the potential that this nonlinear behaviour is caused by the individual flax fibres. In this study the mechanical behaviour of flax fibres tested under uniaxial tension is examined. A total of 30 flax fibres from three separate sources were tested and analysed. As a part of this study, the results of eleven tests will be discussed. Two sets of fibres were extracted from manufactured flax fabrics from Europe (one unidirectional fabric and one bidirectional fabric) and the third set of flax fibres were provided by a flax farm in Nova Scotia, Canada. The primary objective of these tests is to determine if the mechanical behaviour of the flax fibre is the cause of the nonlinear stress-strain response exhibited by flax fibre-reinforced polymers. A preliminary set of tests showed that the stress-strain response of these fibres is bilinear, but the accuracy of these tests needs improvement. To accurately measure the tensile behaviour of the fibres a 1 N load cell was built and programmed. The secondary objective of these tests was to determine the effect of the source of the fibre on the mechanical behaviour. The completed tests showed that the fibres from both manufactured fabrics exhibited a bilinear mechanical response. This is strong evidence that the cause of the nonlinearity of FFRPs is the fibres. This research is in progress and more results will be available at the time of the conference.

### 1 INTRODUCTION

As environmental awareness increases across the globe, it is important that the sustainability of infrastructure is improved. One option to improve sustainability of some structures is the implementation of natural materials. One potential structural application of natural materials is the use of plant fibres, such as flax or hemp, in fibre-reinforced polymer (FRP) composites. FFRPs can be used as sustainable alternatives to synthetic FRPs, such as fibre-glass or carbon-fibre, in structural sandwich panel applications (Mak et al. 2015). These FFRP-foam sandwich panels have been studied under flexure and axial loading in recent past (Codyre et al. 2016; Betts et al. 2017a; Betts et al. 2017b).

To properly model FFRPs and their contribution to structural systems, it is necessary to fully understand their mechanical response. Numerous authors have shown that natural FRPs, including hemp FRPs and FFRPs, exhibit a nonlinear mechanical behaviour (Christian and Billington 2011; Mathura and Cree 2016; Yan et al. 2016; Mak et al. 2015). However, the cause of the nonlinearity is still unknown. The study by Betts et al. (2017c) examines the cause of this nonlinear behaviour by looking at the effect of the FFRP resin, the test specimen shape and the properties of the fibre tows. One conclusion of their study was the hypotheses that the cause of the nonlinear behaviour of FFRPs is the mechanical behaviour of the

individual fibres. Therefore, the current study examines this hypothesis by testing a series of flax fibres under uniaxial tension to determine if the fibres have a nonlinear mechanical behaviour.

To complete the fibre tension tests, a load cell was designed, fabricated, and calibrated. Fibre grips were fabricated and attached to the load cell and a hydraulic piston. Eleven fibres were extracted from bidirectional and unidirectional flax fabrics and tested in tension using the proposed test method.

## 2 PROPOSED TEST METHOD

Elementary flax fibres typically have a diameter of 10 to 20  $\mu\text{m}$  and an ultimate strength of 500 to 900 MPa (Spurnins 2006). Therefore, to measure the tensile load applied to a flax fibre, a small-scale load cell (<1 N) is required. As the smallest available load cell at the university had a capacity of 100 N, a small-scale load cell was designed and fabricated. The load cell design is shown in Figure 1.

Due to the small scale of the tests, the strain measurement was based on the test stroke. As shown in Figure 1, the bottom fibre grip was attached to the hydraulic piston of an Instron 8501 test frame. The tests were performed at a constant displacement rate of 0.01 mm/s and the test specimens had a gauge length of 10 mm. Therefore, the strain could be calculated based on the time, displacement rate and gauge length.

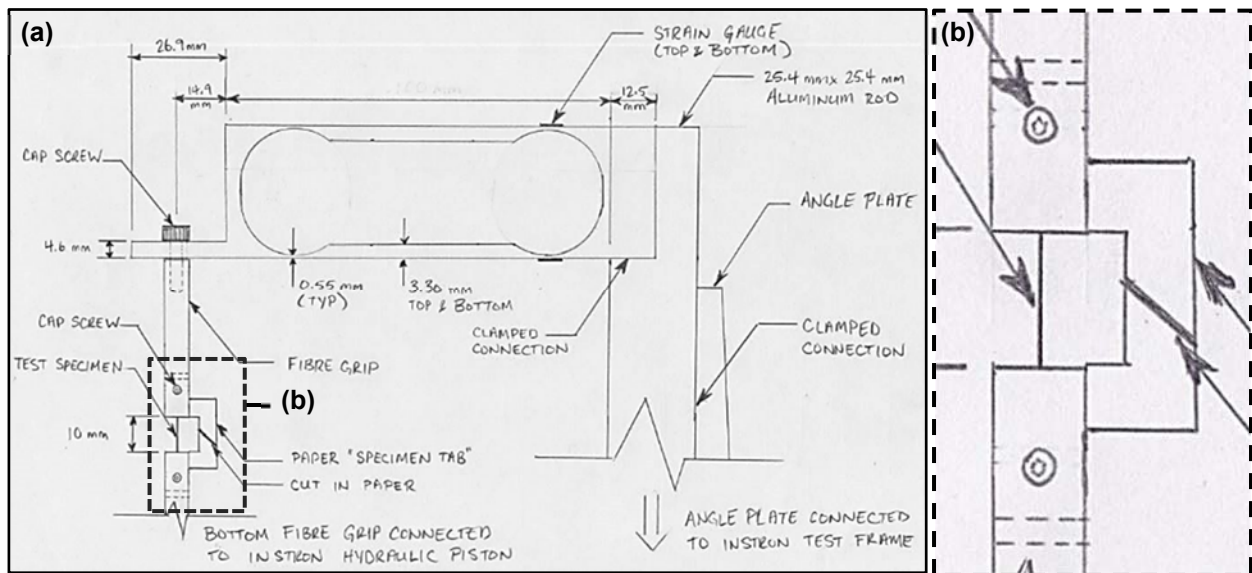

Figure 1: Load cell design: (a) general schematic and (b) detail of fibre grips

The fibre grip was fabricated using an aluminium rod with a diameter of 10 mm. The grip design is shown in Figure 2. Each fibre was glued to a paper tab which had been cut to the correct gauge length. The prepared fibre was then placed into the bottom grip which was closed by tightening the cap screw using an Allen Key. The bottom grip and fibre were then raised into the top grip which was tightened in the same manner. Once both grips were tightened, the bottom grip was raised to ensure that there was no tensile force on the specimen (ie. the distance between the grips was less than the gauge length of the specimen). The paper tab was then cut as shown in Figure 1a. Finally, the bottom grip was lowered until the fiber specimen was almost taut. The test was then ready to start.

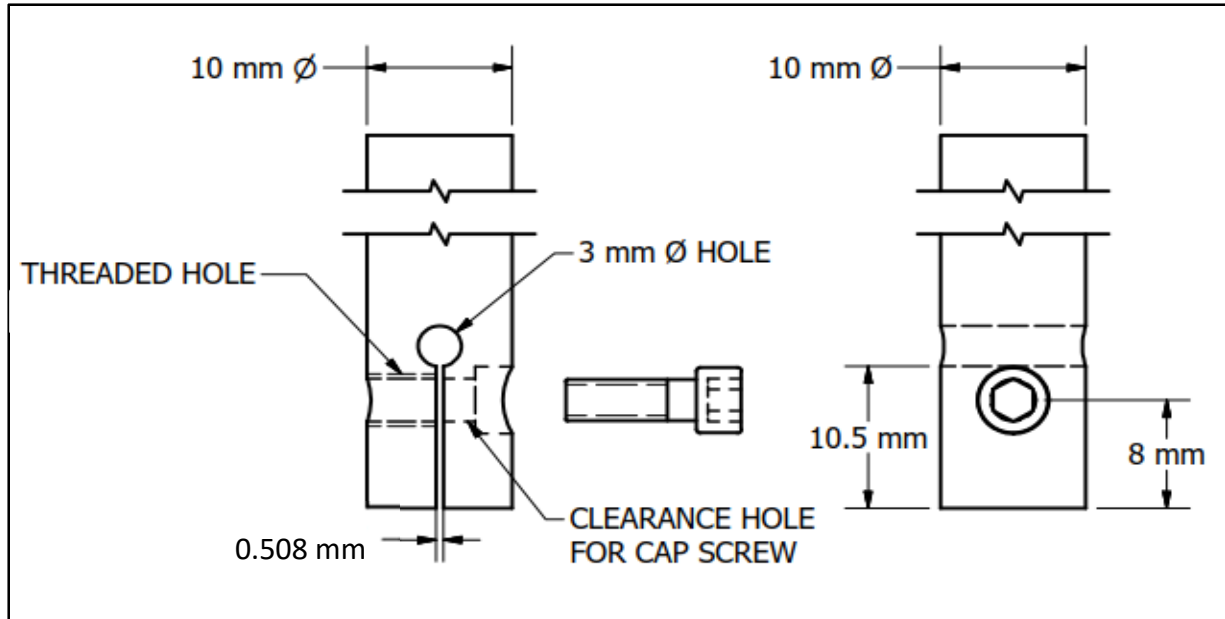

Figure 2: Fibre grip design

The load cell was fabricated using a section of aluminium which was cut using an end mill. The output of the load cell is a strain reading from the strain gauge on the top of the load cell which was placed near the rigid clamped connection to an aluminium rod. Ten known weights were placed on the fixture to calibrate the load cell. The data calibration was completed in the scientific python package, Anaconda, as was the post-processing of the data. The masses of these know weights and the corresponding strain readings from the load cell are provided in Table 1. Based on the values presented in Table 1, the data was calibrated using a linear fit, as shown in Figure 3.

Table 1: Load cell calibration masses

Calibration Mass (g)	Cumulative Mass (g)	Load (N)	Load Cell Output ( $\mu\epsilon$ )
0	0	0	-545
4.40	4.40	0.04316	-534
4.88	9.28	0.09104	-519
4.88	14.16	0.13891	-506
4.85	19.01	0.18649	-492
4.92	23.93	0.23475	-477
4.91	28.84	0.28292	-465
4.82	33.66	0.33020	-451
4.96	38.62	0.37886	-437
4.30	42.92	0.42105	-425
4.86	47.78	0.46872	-411

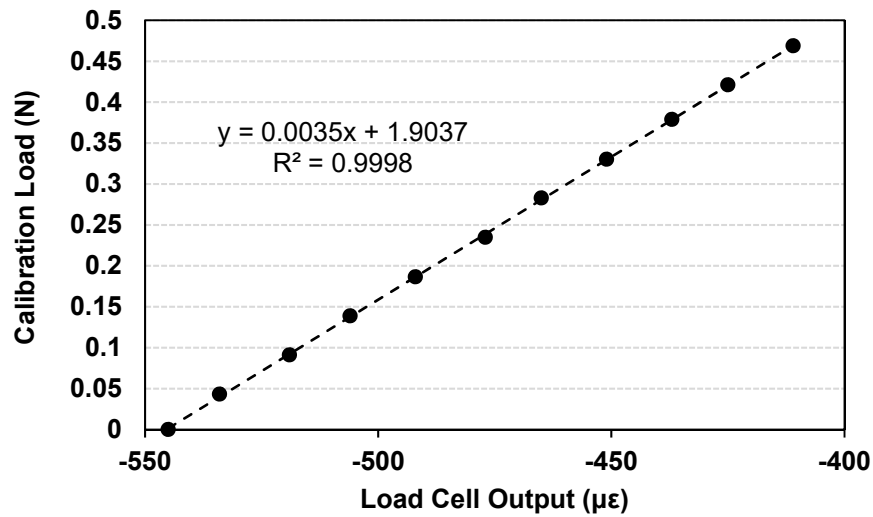

Figure 3: Load cell calibration

The post-processing of the data was performed by a program written in the Python programming language. The program takes the test data, the specimen diameter, the gauge length and the displacement rate as preliminary inputs. It plots the raw data and prompts the user to define the range of the valid test data (i.e. eliminate the data recorded before the testing began and remove the data recorded after the specimen was broken) by providing start and end indices of the valid section of data. The program then implements a moving average filter with an N-value of 100 which improves the resolution of the data from approximately 0.02 N to approximately 0.002 N, which is an improvement by a factor of 10.

Once the data has been averaged, the program converts load to stress using the fibre diameter and time to strain using the gauge length and displacement rate. Figure 4 shows an example of the raw data plotted by the program and the final stress-strain diagram plotted by the program.

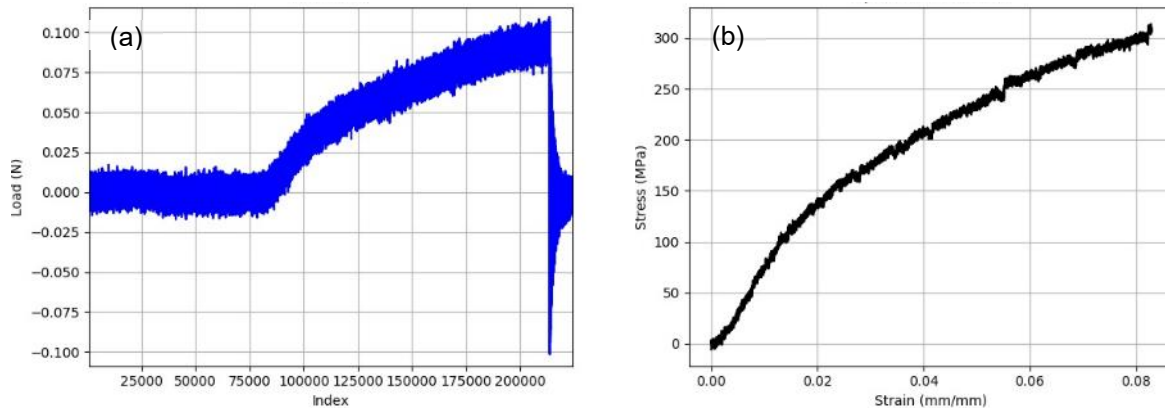

Figure 4: Post-processing program outputs for specimen FF-5 (a) raw load data (b) stress-strain diagram

### 3 FIBRE TESTS

Thus far, eleven flax fibres have been tested in uniaxial tension as a part of this study. Each specimen had a gauge length of 10 mm and was tested at a rate of 0.01 mm/s using an Instron test frame and the load

cell as described in the previous section. Nineteen more fibres will be tested as a part of this study; the full test matrix is presented in Table 2.

Table 2: Test matrix

Specimen Group	Source Location	Source Details	Number of Specimens	Number of Specimens Tested
FF-NS	Nova Scotia	Farmed fibre	10	N/A
FF-BD	United Kingdom	Extracted from 2x2 twill flax fabric	10	5
FF-UD	United Kingdom	Extracted from unidirectional flax fabric	10	6

Figure 5 shows a picture of the tensile test set-up used for the tests of the first eleven specimens. The specimens were carefully extracted from a 2x2 twill flax fabric using tweezers and glued to paper specimen tabs which were cut to the gauge length of 10 mm. The specimen was then placed in the fibre grips and fixed in place by tightening the cap screws. Once the fibre and paper tab were in place the paper tab was cut (as seen in Figure 5b) and the test was ready to start.

#### 4 RESULTS AND DISCUSSIONS

The results of the tested specimens are presented in Table 3. Figure 6 shows the stress-strain plots of the tested specimens. The tested fibres were not observed under a microscope to obtain an accurate measurement of diameter and therefore the stress calculations were based on a nominal fibre diameter of 19.93  $\mu\text{m}$ . This value was determined by taking the average of the fibre diameters from a previous set of preliminary tests. In these previous tests, three photos along the length of each fibre were captured using a microscope. Then the diameter of each fibre was measured at six points along the fibre length using an image processing software. Based on scanning electron microscope (SEM) imagery as shown in Figure 7, it is known that the fibres have a hollow cross section. However, for the calculation of stress in this study, this was neglected; that is, the gross cross-sectional area was used for the stress calculations. Upon examination of the data, it was determined that specimen FF-BD-3 experienced pre-mature failure and therefore, it was not used when calculating the average values shown in Table 3 and Figure 6. This pre-mature failure could have been caused from specimen handling or been due to a defect in the fibre prior to extraction from the flax fabric.

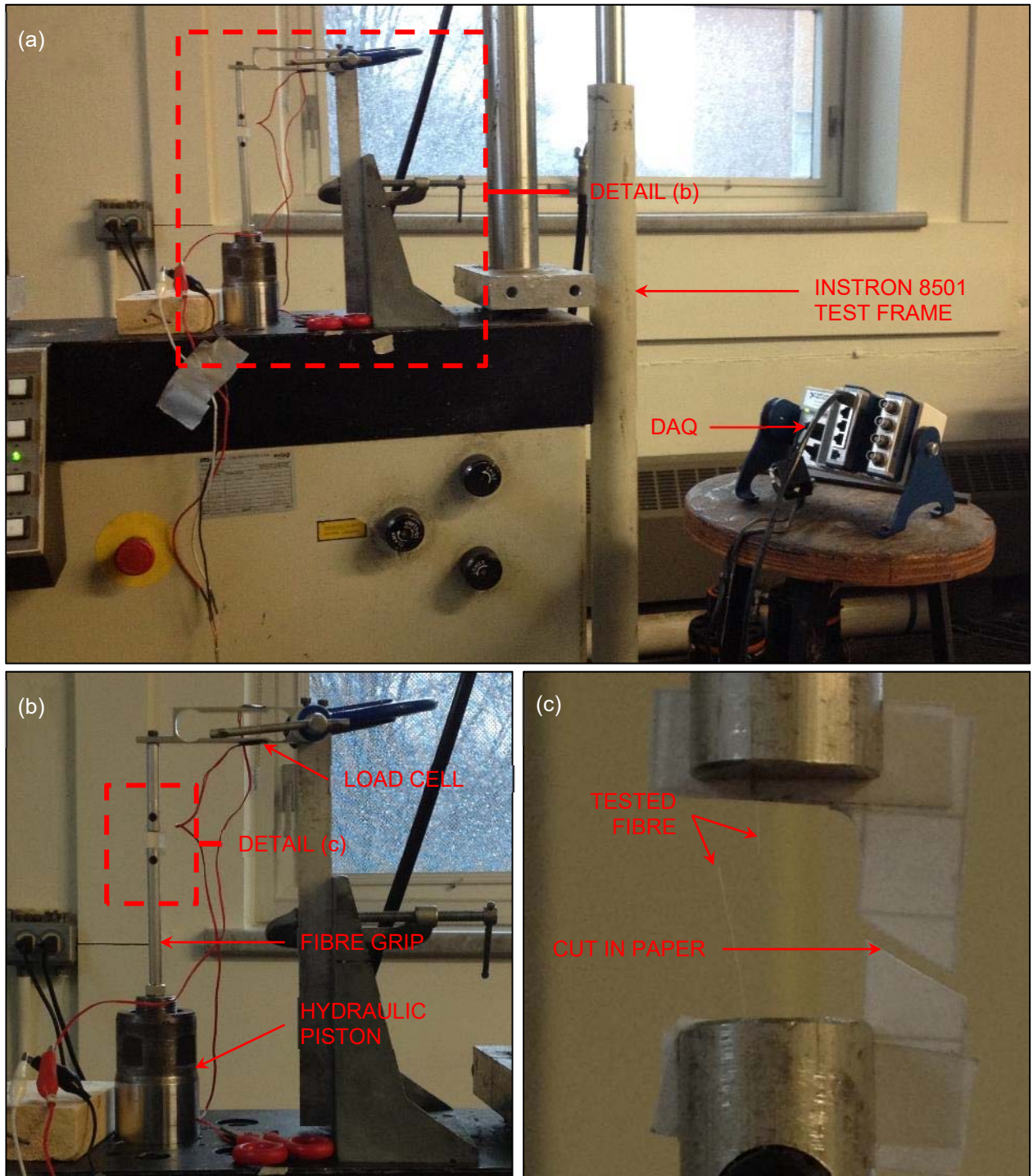

Figure 5: Test set-up (a) general test set-up and (b) detail of a tested fibre

Table 3: Fibre test results

Specimen	Primary Modulus (GPa)	Secondary Modulus (GPa)	Secondary to Primary Modulus (%)	Tensile Strength (MPa)	Ultimate Strain (mm/mm)
FF-BD-1	7.67	4.43	58	352	0.0622

Specimen	Primary Modulus (GPa)	Secondary Modulus (GPa)	Secondary to Primary Modulus (%)	Tensile Strength (MPa)	Ultimate Strain (mm/mm)
FF-BD-2	8.16	2.15	26	265	0.0939
FF-BD-3 *	4.69	N/A	N/A	182	0.0389
FF-BD-4	6.67	1.93	29	295	0.0868
FF-BD-5	8.69	2.45	28	314	0.0829
Average	7.80	2.74	35	307	0.0815
St. Dev.	0.86	1.15	15	36	0.0136
FF-UD-1	6.82	2.76	40	316	0.0736
FF-UD-2	10.95	2.47	23	286	0.0646
FF-UD-3	7.71	3.54	46	379	0.0714
FF-UD-4	11.88	2.91	24	333	0.0691
FF-UD-5	8.33	2.99	36	313	0.0607
FF-UD-6	9.70	3.46	36	385	0.0837
Average	9.23	3.02	34	335	0.0705
St. Dev.	1.96	0.41	9	39	0.0080

\* Presumed premature failure; not included in the average and standard deviation (St. Dev.) calculations

Table 3 shows that the mechanical properties of the FF-UD and FF-BD fibres are similar and both show that the secondary modulus is approximately one third of the primary fibre modulus. Interestingly, the paper by Betts et al. (2017c) showed that the secondary modulus of FFRPs is approximately two thirds of the primary modulus. Upon examination of Table 3, it seems that the primary modulus, secondary modulus, and ultimate strength of the unidirectional fibres are higher than the bidirectional fibres; however, an analysis of variance (ANOVA) with a confidence level of 95% shows that the difference between the groups is statistically negligible.

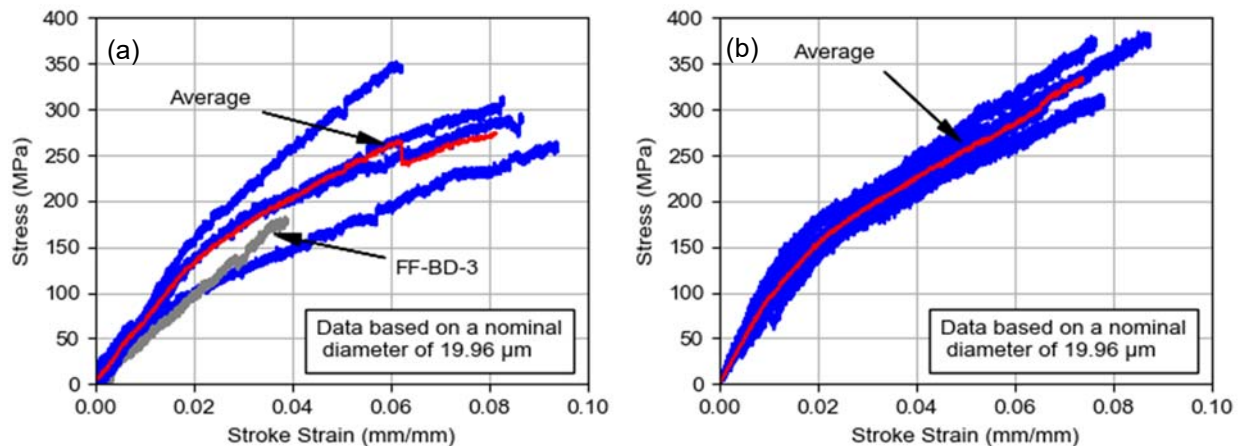

Figure 6: Stress-strain plots of tested flax fibers (a) FF-BD specimens (FF-BD-3 not included in the average) and; (b) FF-UD specimens

#### 4.1 Nonlinear Behaviour of Flax Fibres

As shown in Figure 6, the tested specimens (excluding FF-BD-3) all showed a nonlinear mechanical response to the tensile loading. This result is evidence that the nonlinear behaviour of their composites is potentially caused by the nonlinear nature of the individual fibres. Future studies will include an in-depth analysis of the effect of the fibre nonlinearity on FFRP nonlinearity as well as determining the cause of the fibre nonlinearity.

Per Sparnins (2006), elementary flax fibres are made up of smaller meso fibrils and micro fibrils. This was also observed by the authors as shown in SEM photograph of a flax fibre shown in Figure 7. The current hypothesis of fibre nonlinearity is that until the transition point, the meso and micro fibrils work together and provide the primary fibre stiffness. At that point, the micro fibrils fail and the overall stiffness of the fibre is reduced until ultimate failure of the meso fibrils.

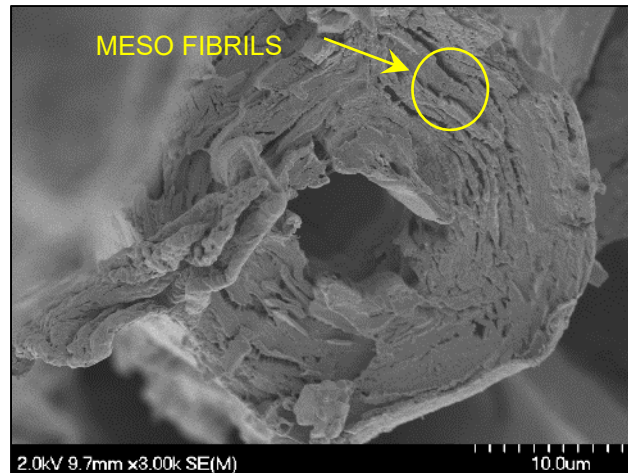

Figure 7: SEM photograph of elementary flax fibre

#### 4.2 Effect of Flax Fibre Behaviour on Composite Behaviour

The unidirectional fibres (i.e. FF-UD specimens) were extracted from the same fabric used in the previous study by (Betts et al. 2017c). Figure 8 presents a plot comparing the results of the fibres, the matrix, and the composite. As discussed later, the strain data provided by the tests is erroneously high. Therefore, to better compare the fibres with the matrix and composite, the fibre strain data was calibrated using data from the study by Betts et al. (2017c). Figure 8a shows the fibre data calibrated using Rule of Mixtures using the simplifying assumption that the composite had no voids. Figure 8b shows the fibre data calibrated such that the rupture strain of the fibre matches the composite rupture strain. To accurately compare the fibre, matrix and composite, a more accurate measurement of strain data is required.

Additionally, based on the data by Betts et al. (2017c), the maximum stress estimation of the fibres according to rule of mixtures would be 273 MPa. As shown in Table 3, the unidirectional fibre tests showed a maximum stress of 335 MPa. Because the FFRPs exhibited a nonlinear mechanical behaviour, the rule of mixtures may not accurately predict the behaviour of the fibres which could be the cause of this discrepancy.



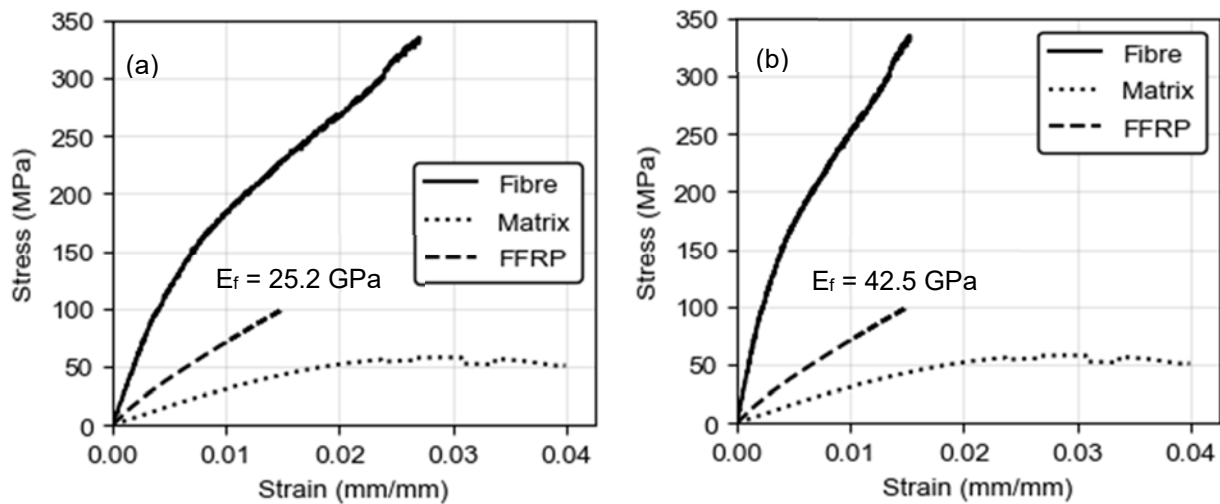

Figure 8: Effect of flax fibres on composite behaviour (a) strain data adjusted to Rule of Mixtures (b) strain data adjusted to composite rupture

### 4.3 Sources of Error

The young's modulus of flax fibres is typically between 50 GPa and 70 GPa (Spurnins 2006), therefore upon examination the data presented in Table 3, it is apparent that the modulus values determined through testing are low. This is most likely due to erroneously high strain readings, which could be explained by several sources of error, including:

- a. Load cell deflection
- b. Incorrect gauge length estimation, which is affected by:
  - i. fibre twist (or "waviness")
  - ii. fibre placement on the paper tabs
- c. Fibre slippage
- d. The use of a nominal fibre diameter
- e. Neglecting the deduction of cross-sectional area due to the fibre hollowness.
- f. Fibre fragility (potential to damage fibre before testing)

Some of these sources of error can be mitigated by implementing additional protocols into the test procedure. These protocols include: using an LVDT to measure the deflection of the load cell, using a laser extensometer to measure displacement between fibre grips and measuring the individual fibre diameters before testing.

## 5 CONCLUSIONS

As a part of this study thirty fibre specimens will be tested in uniaxial tension using a load cell that was designed and fabricated by the authors. Thus far, eleven of the flax fibre specimens have been tested. The results of the tests show that the fibres extracted from the bidirectional fabric have an ultimate tensile strength of 307 MPa and the fibres extracted from the unidirectional fabric have an ultimate tensile strength of 335 MPa. The rule of mixtures predicts an ultimate strength of 273 MPa, however, this discrepancy could be caused by the nonlinear nature of flax fibres and FFRPs. Fibres extracted from both sources exhibit a nonlinear mechanical response, specifically a bilinear response where the secondary modulus is approximately one third of the primary modulus. This supports the hypothesis that the nonlinear behaviour of flax fibre-reinforced polymers is caused by the behaviour of the individual fibres. Currently, the strain estimation is erroneously high which affects the calculation of the young's modulus. The implementation of additional protocols in the test procedure will help mitigate the sources of error. This study is a part of

ongoing research and future studies include: testing of more fibres from different sources, determining cause of fibres' nonlinear behaviour and studying the effect of growth location.

### Acknowledgements

The authors would like to thank Brian Kennedy and Jesse Keane for their assistance in the lab and acknowledge the use of the fibre grip design by John Noddin and Kevin Borgel. The authors would also like to thank Bioindustrial Innovation Canada (BIC), Queen's University and Dalhousie University for their in-kind financial support.

### References

- Betts, D, Sadeghian, P, and Fam A. 2017a. Cumulative Impact Energy Absorption of Sandwich Panels with Foam Cores and Flax FRP Faces. *17th International Conference on Non-Conventional Materials and Technologies*, Merida, Yucatan, Mexico, 1–10.
- Betts, D, Sadeghian, P, and Fam A. 2017b. Structural Behaviour of Sandwich Panels Constructed of Foam Cores and Flax FRP Facings. *CSCCE Annual Conference*. Vancouver, BC, Canada, 1–10.
- Betts, D, Sadeghian, P, and Fam A. 2017c. Tensile Properties of Flax FRP Composites. *Asia Pacific Conference on FRP in Structures*. Singapore. 1-4.
- Christian, S J, and Billington, S L. 2011. Composites : Part B Mechanical Response of PHB- and Cellulose Acetate Natural Fiber-Reinforced Composites for Construction Applications. *Composites Part B* **42** (7): 1920–1928.
- Codyre, L, Mak, K, and Fam, A. 2016. Flexural and Axial Behaviour of Sandwich Panels with Bio-Based Flax Fibre-Reinforced Forced Polymer Skins and Various Foam Core Densities. *Journal of Sandwich Structures and Materials*, 1–22.
- Mak, K, Fam, A, MacDougall, C. 2015. Flexural Behavior of Sandwich Panels with Bio-FRP Skins Made of Flax Fibers and Epoxidized Pine-Oil Resin. *Journal of Composites for Construction* **19**(2003): 1–13.
- Mathura, N, and Cree, D. 2016. Characterization and Mechanical Property of Trinidad Coir Fibers. *Journal of Applied Polymer Science* **133**(29): 1–9.
- Sparnins, E. 2006. Mechanical Properties of Flax Fibers and Their Composites. Lulea University of Technology.
- Yan, L, Kasal, B, and Huang, L. 2016. A Review of Recent Research on the Use of Cellulosic Fibres, Their Fibre Fabric Reinforced Cementitious, Geo-Polymer and Polymer Composites in Civil Engineering. *Composites Part B: Engineering*, **92**(April): 94–132.